

Utilizando las medidas recomendadas, se obtiene un modelo final de 10 cms.

<b>Autor:</b>	Halle
<b>Nivel de dificultad:</b>	Baja
<b>Número de piezas:</b>	9
<b>Forma de las piezas:</b>	Cuadrados

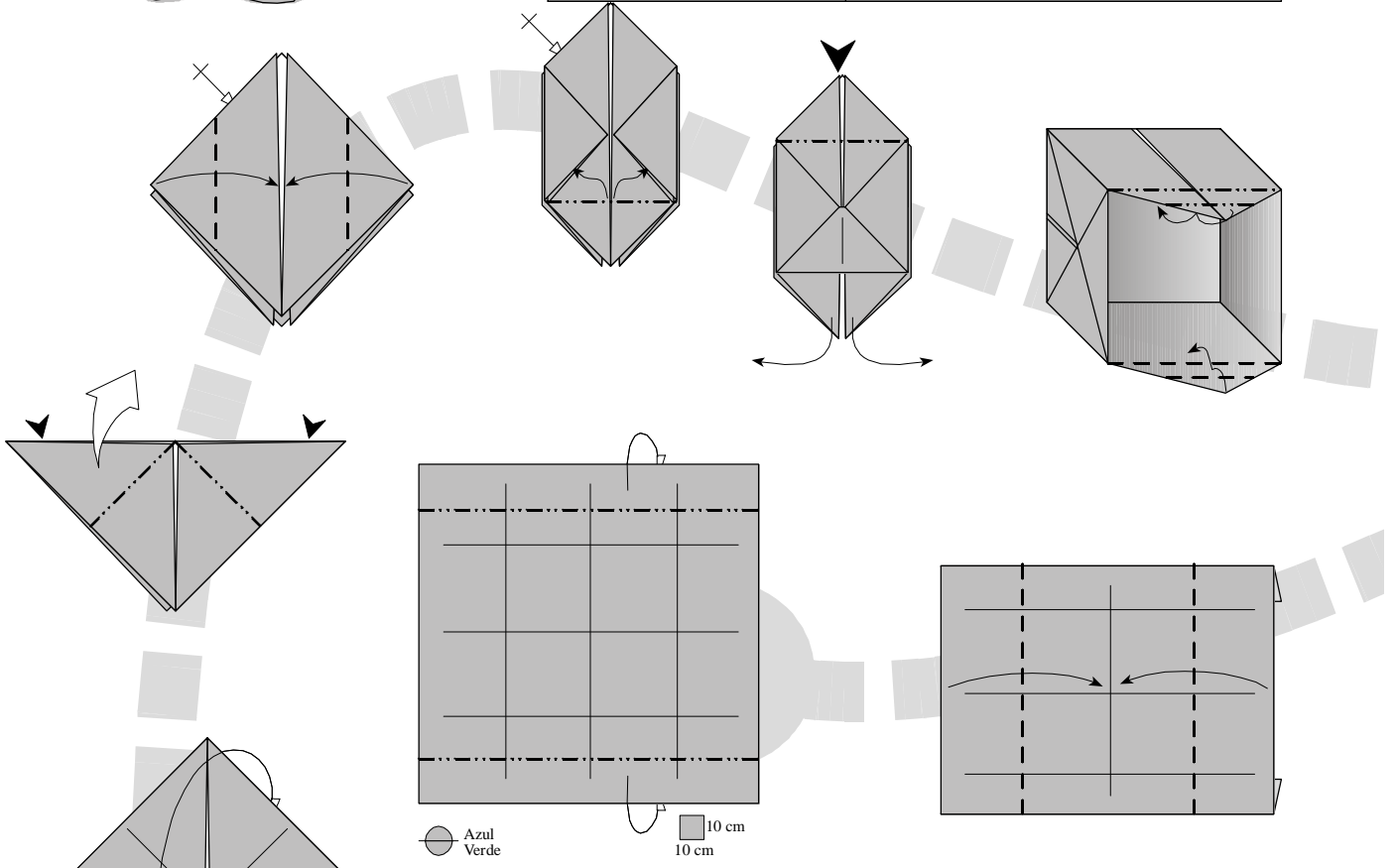

Discover others models by Halle and download new diagrams at <http://design.origami.free.fr>

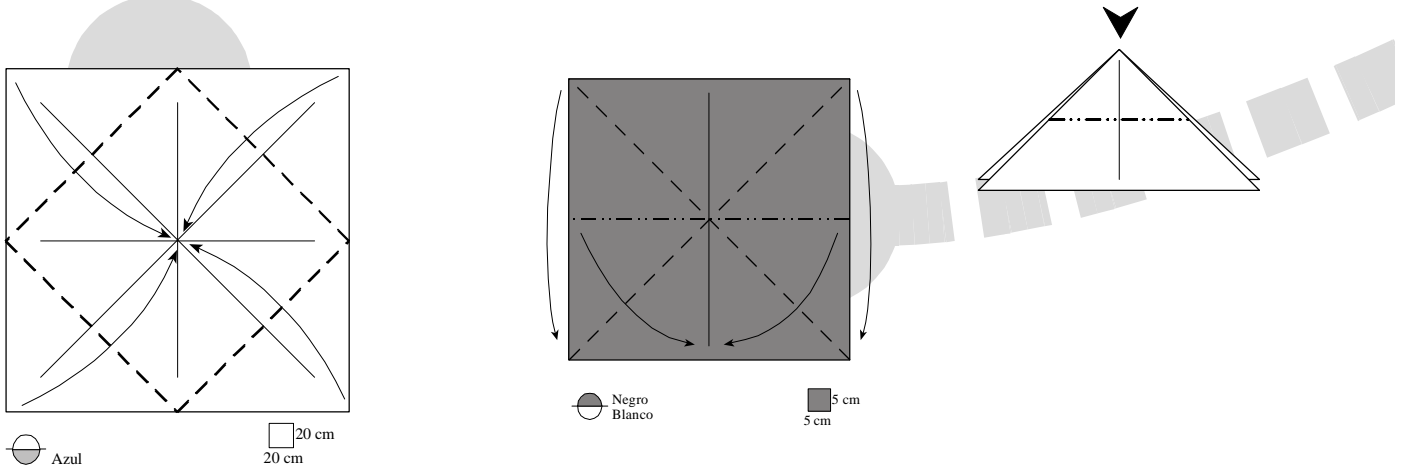

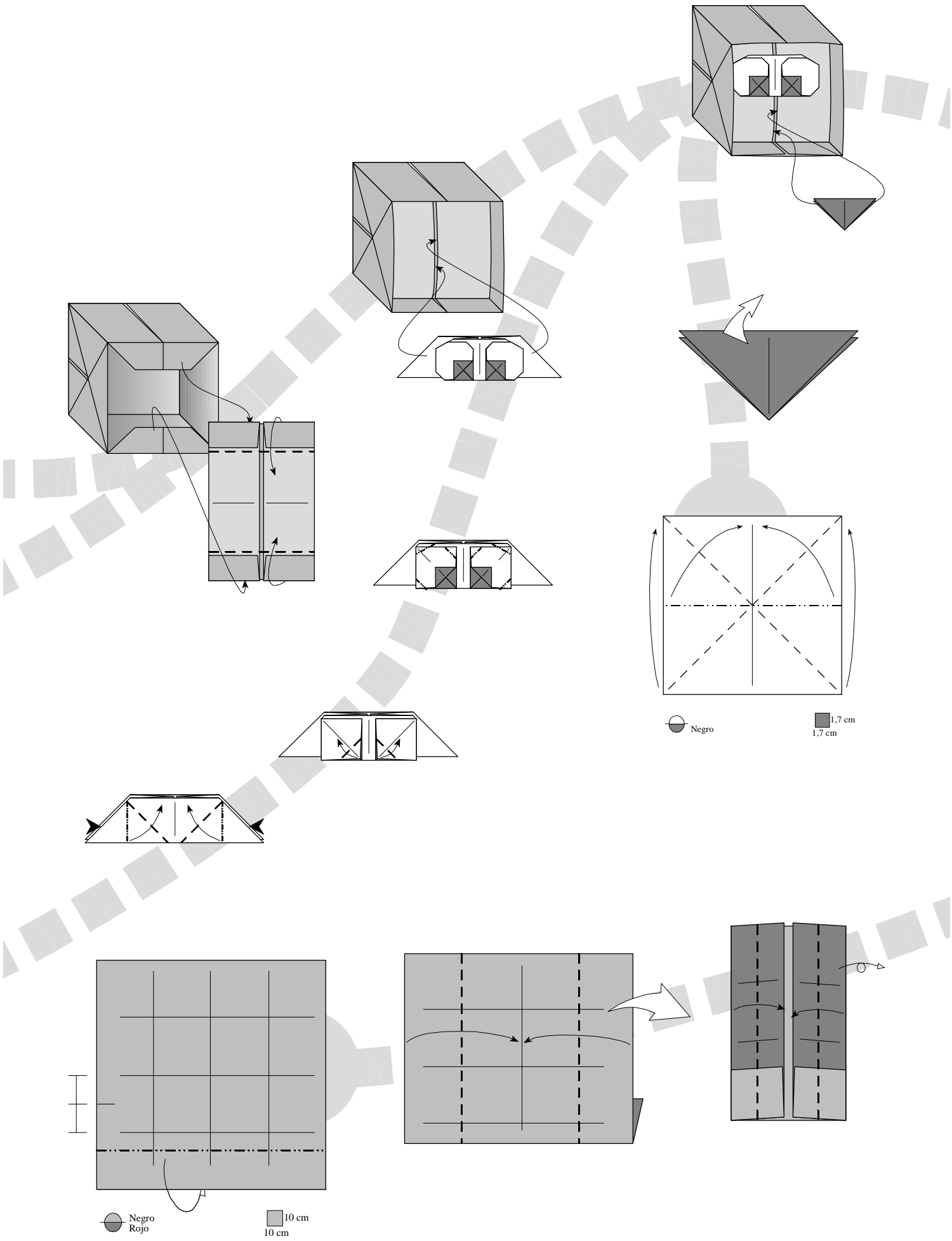



La boca admite muchas posibilidades, dependiendo de la base de que partamos y con muy pocos plegados podemos obtener gran variedad de expresiones

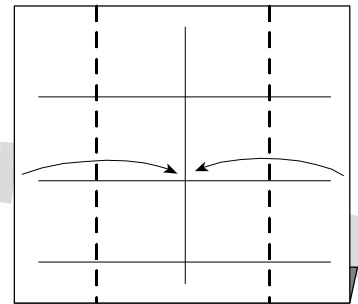
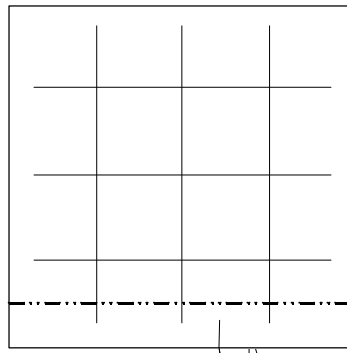
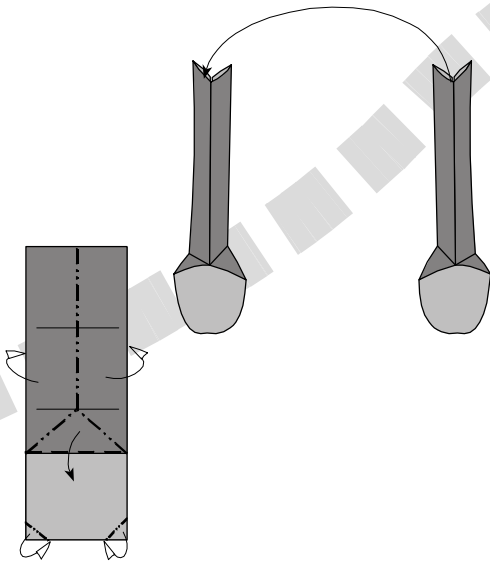
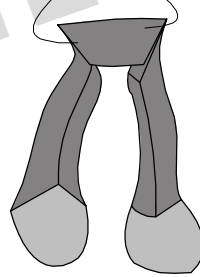
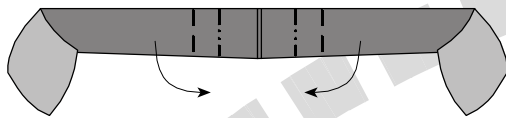
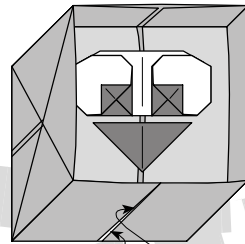
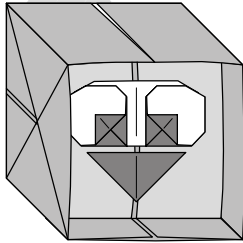
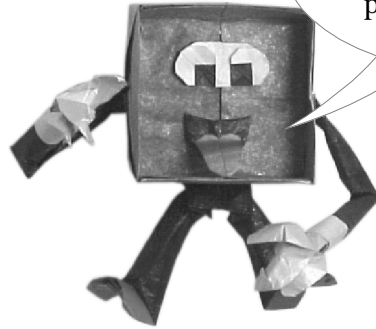

● Blanco  
● Negro

□ 10 cm  
□ 10 cm

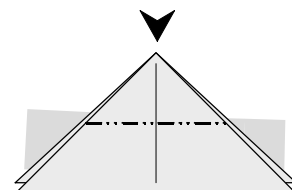
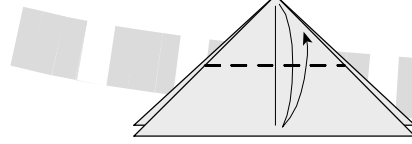
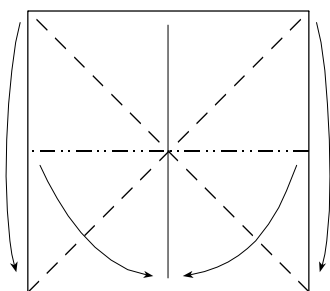

● Amarillo

□ 5 cm  
□ 5 cm

Las muchas ranuras que tiene "Webby", nos facilita la unión de los brazos con el cuerpo, permitiendonos además una gran variedad de posiciones para estos e incluso podemos ponerle sombrero.

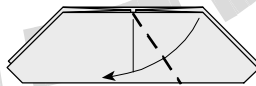
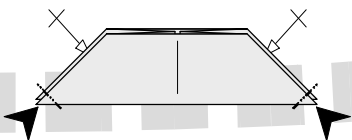
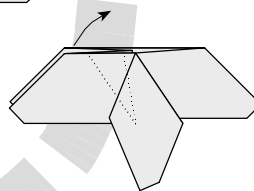
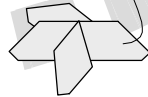
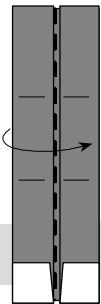
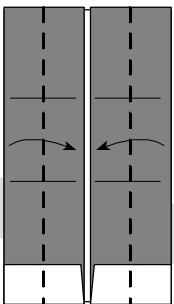
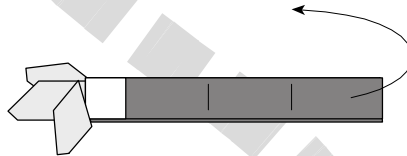
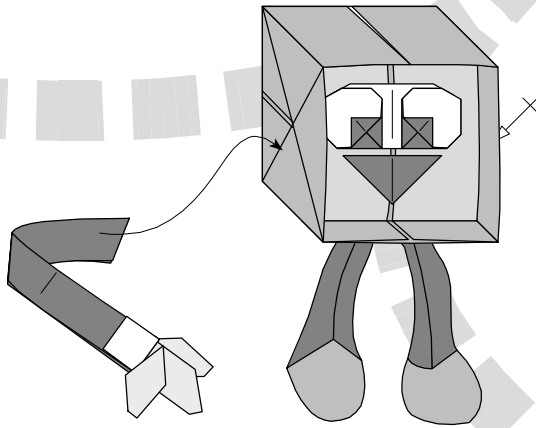
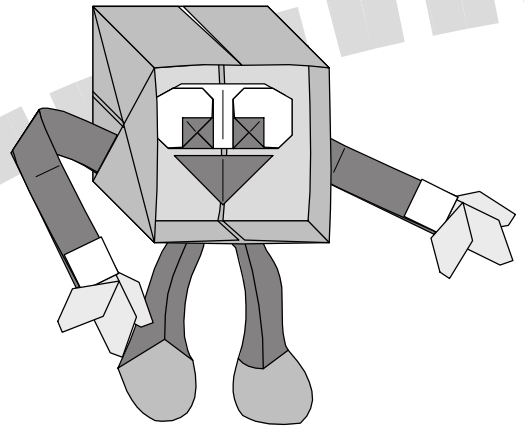
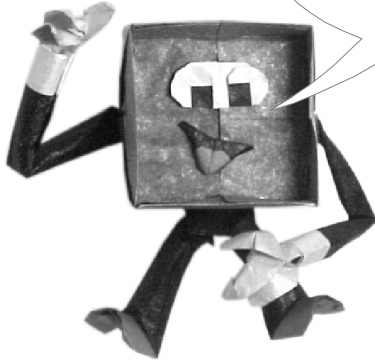
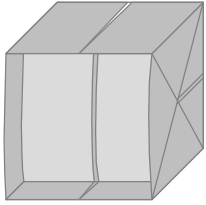

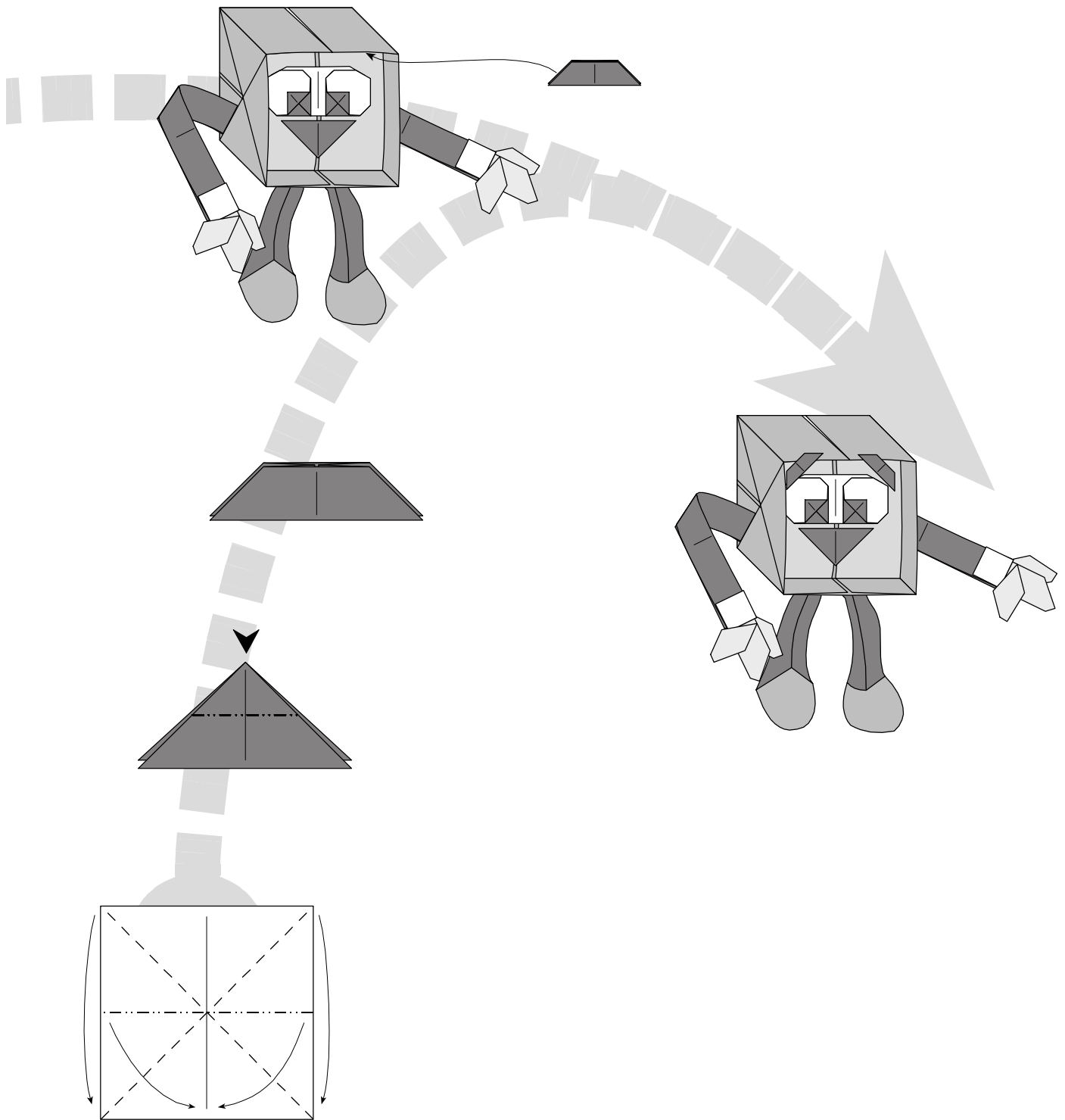

● Negro

■ 2,5 cm  
2,5 cm