

Pacific Giant Red Sea Urchin

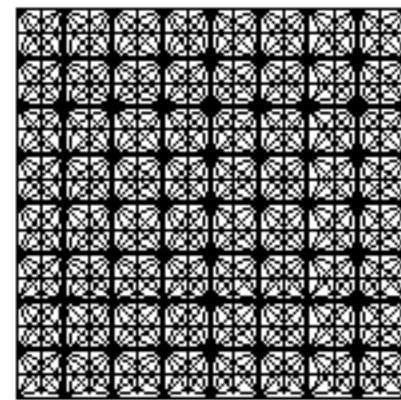

Based on Robert J. Lang's "Atlantic Purple Sea Urchin".
Use paper that doesn't tear easily, or use foil-backed paper.
Use a square measuring at least 30 inches (75 cm) to a side.
Begin with the white side up.

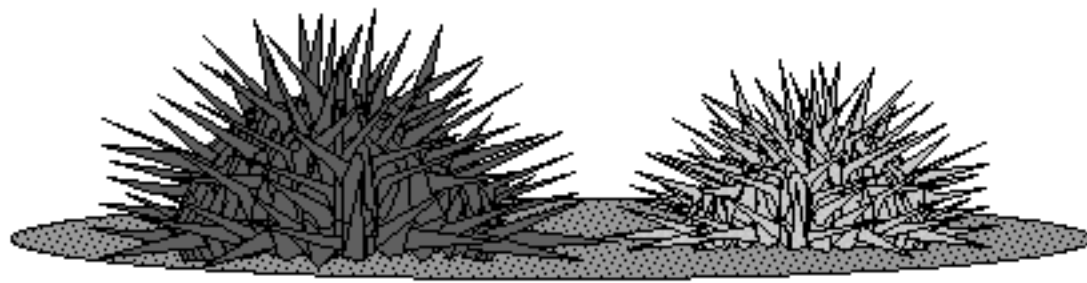
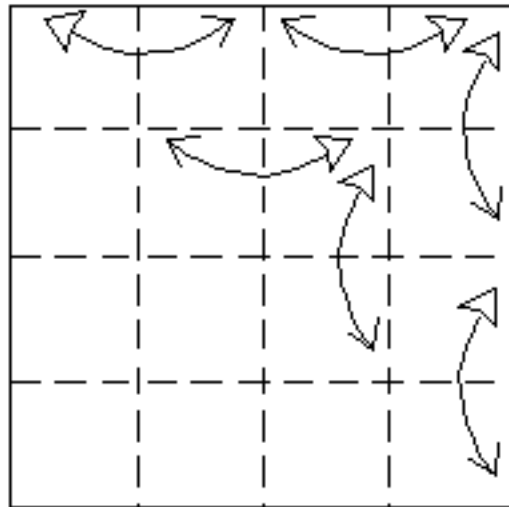

1. Crease the paper into fourths vertically and horizontally.

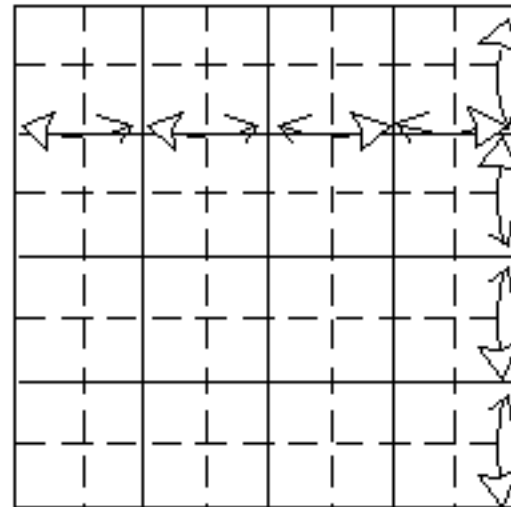

2. Crease the paper into eights vertically and horizontally.

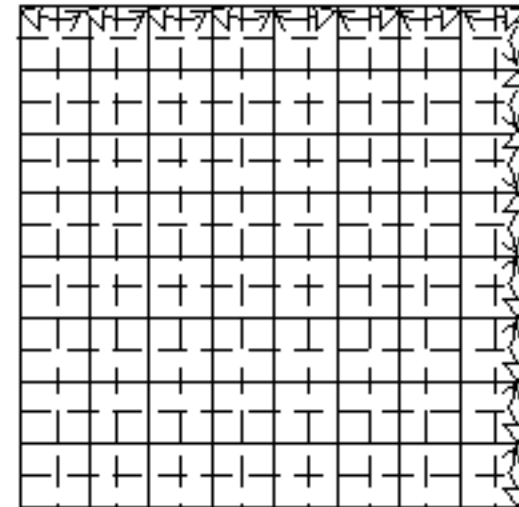

3. Crease the paper into sixteenths vertically and horizontally.

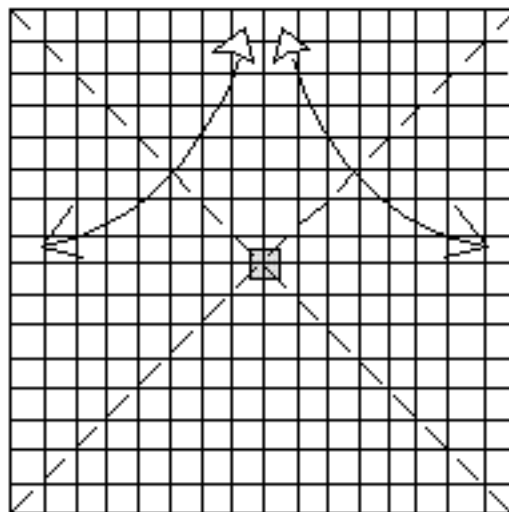

4. Crease the diagonals. For extra safety, put a piece of tape at the center of the paper.

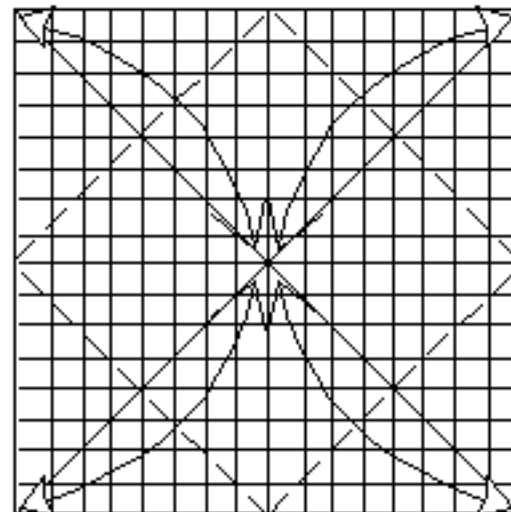

5. Bring the corners to the center, crease, and unfold.

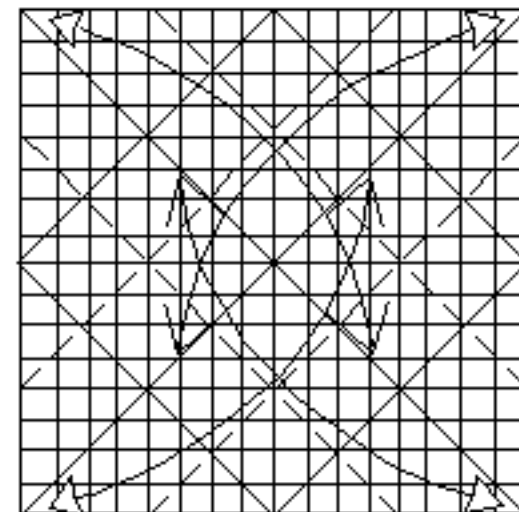

6. Add more diagonal creases.

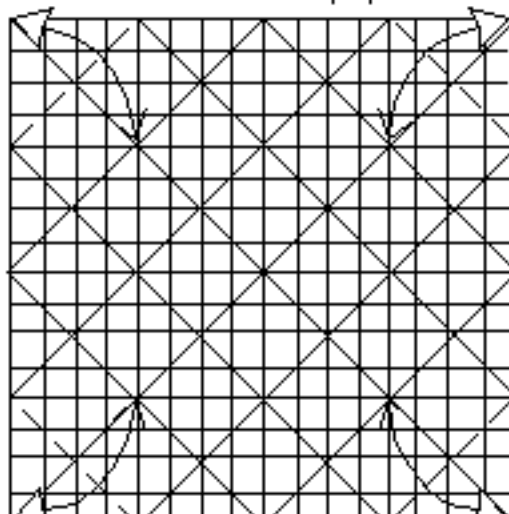

7. And more.

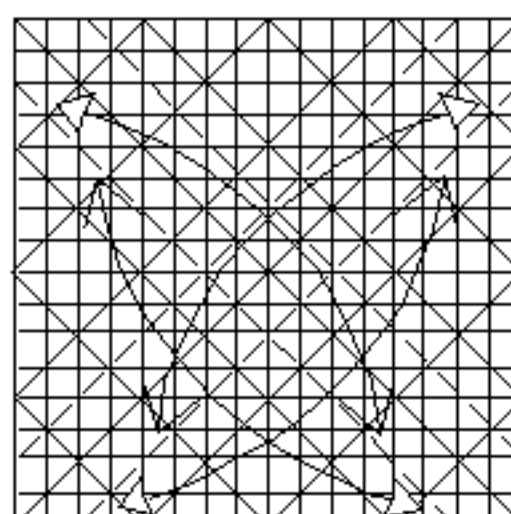

8. And more.

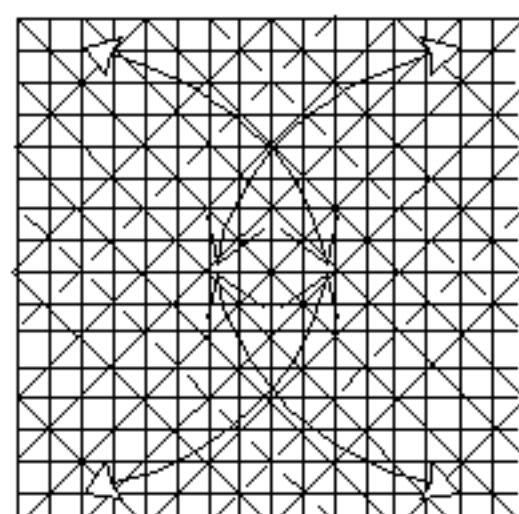

9. And more.

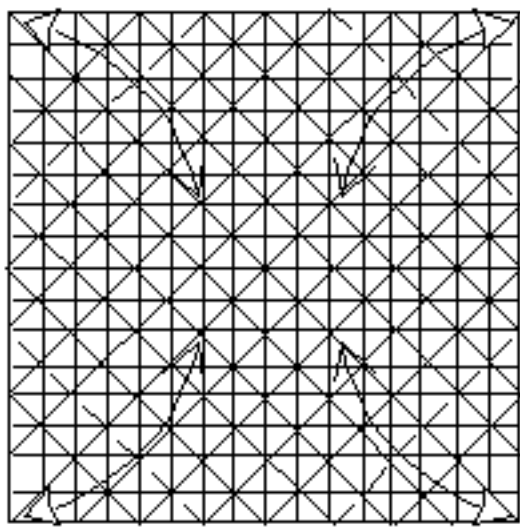

10. And more.

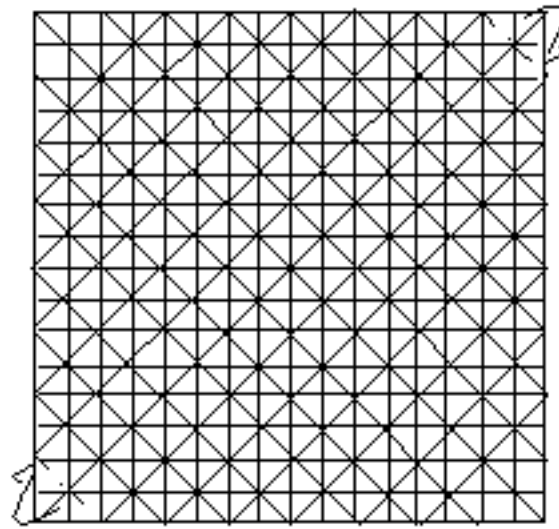

11. Mountain-fold two opposing corners behind.

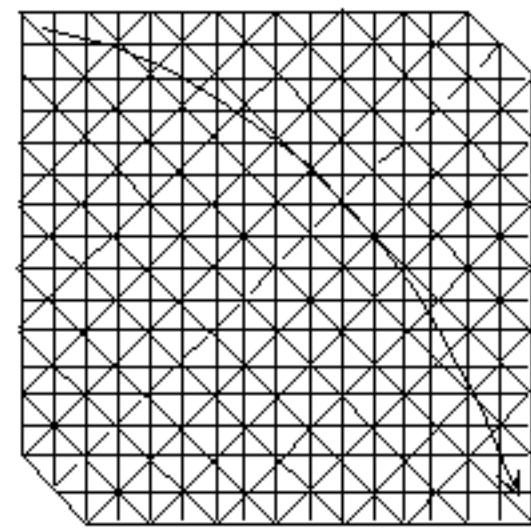

12. Valley-fold in half.

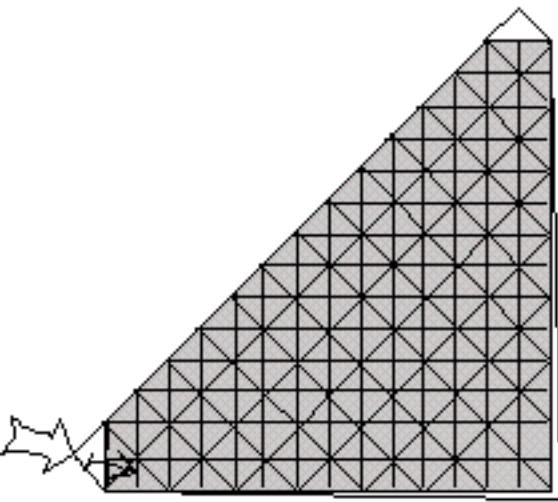

13. Squash-fold.

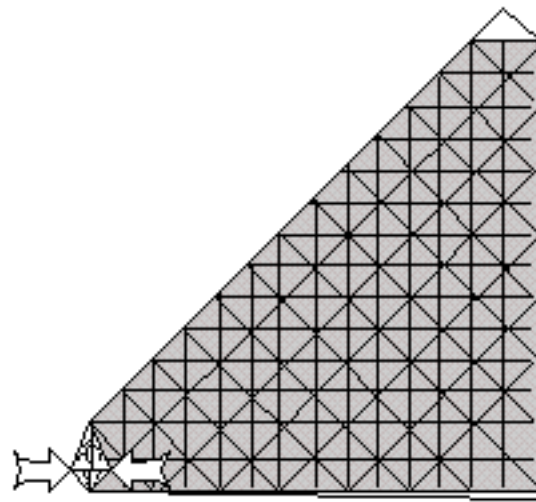

14. Petal-fold.

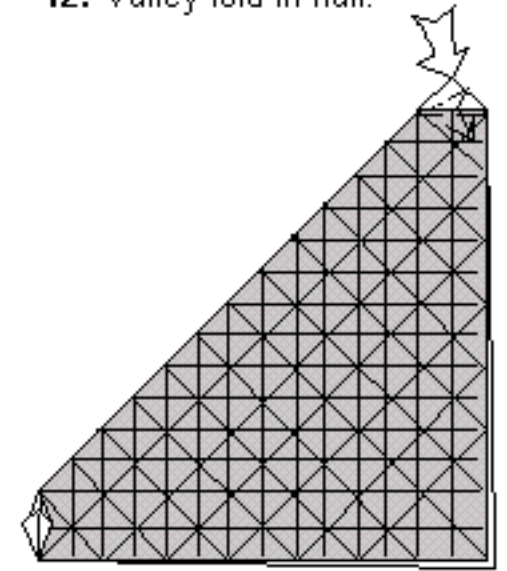

15. Repeat steps 13 - 14 on the top corner and unfold to step 11.

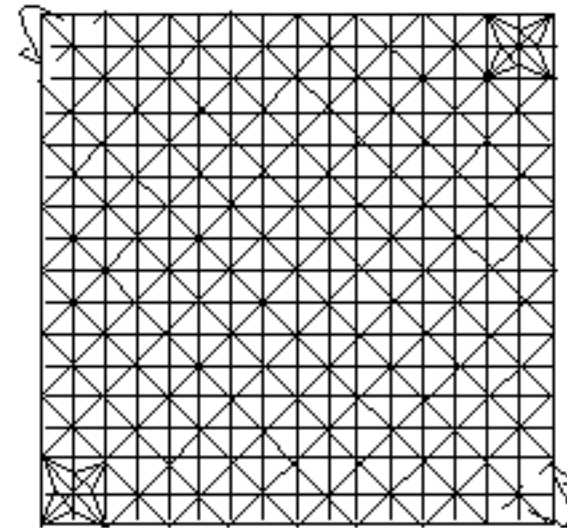

16. Repeat steps 11 - 15.

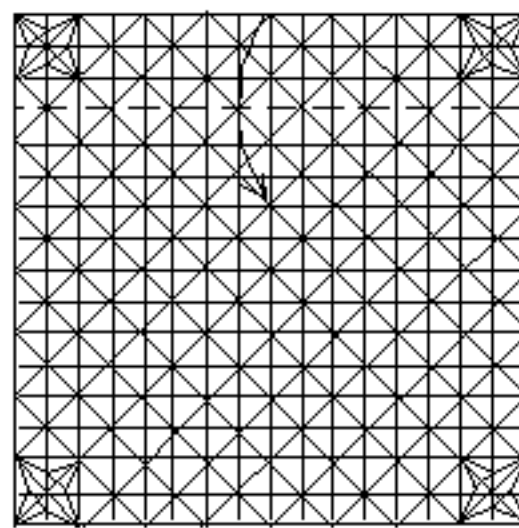

17. Valley-fold.

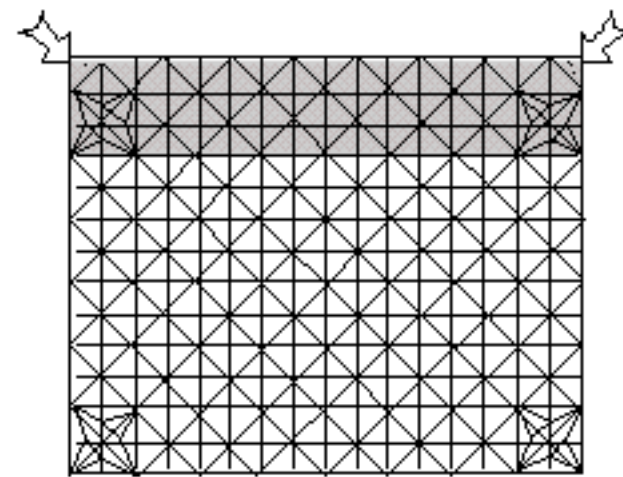

18. Reverse-fold along angle bisectors and unfold completely. Repeat on all similar places along the edges of the square.

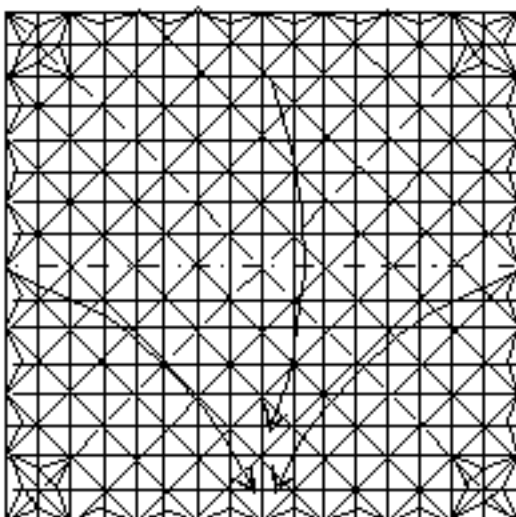

19. Precreasing complete. Fold a Waterbomb Base.

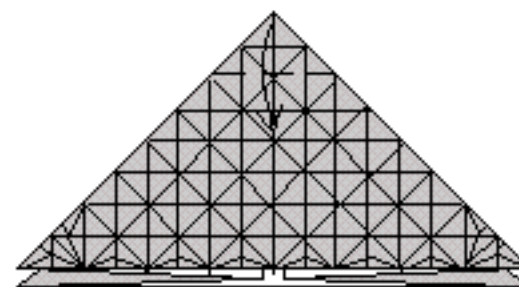

20. Valley-fold.

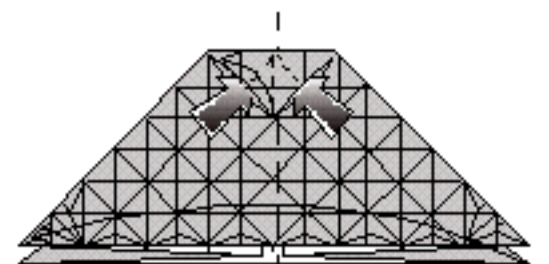

21. Open up on both sides of the top corner and fold the right side of the model over to the left.

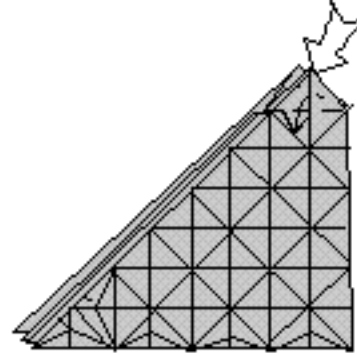

22. Squash-fold.

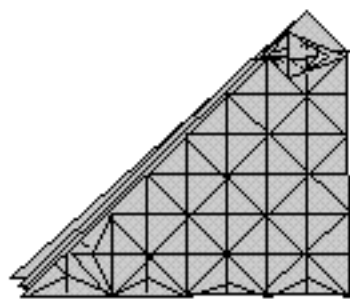

23. Petal-fold.

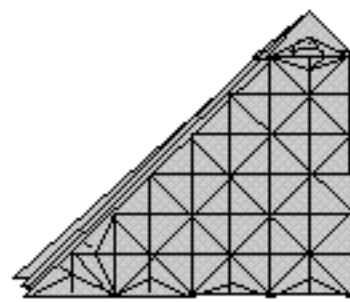

24. Valley-fold the flap to the left.

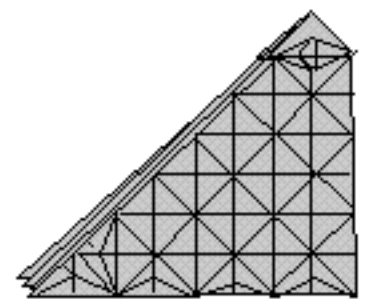

25. Repeat steps 22 - 24 behind and unfold to step 20. Turn the model over.

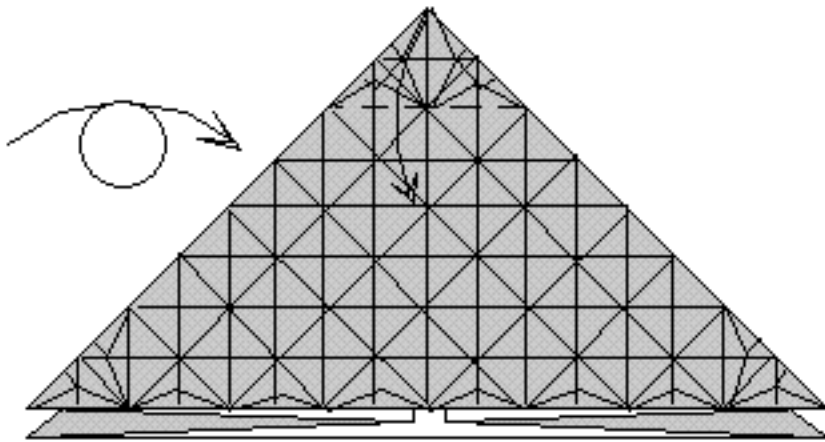

26. Repeat steps 20 - 25.

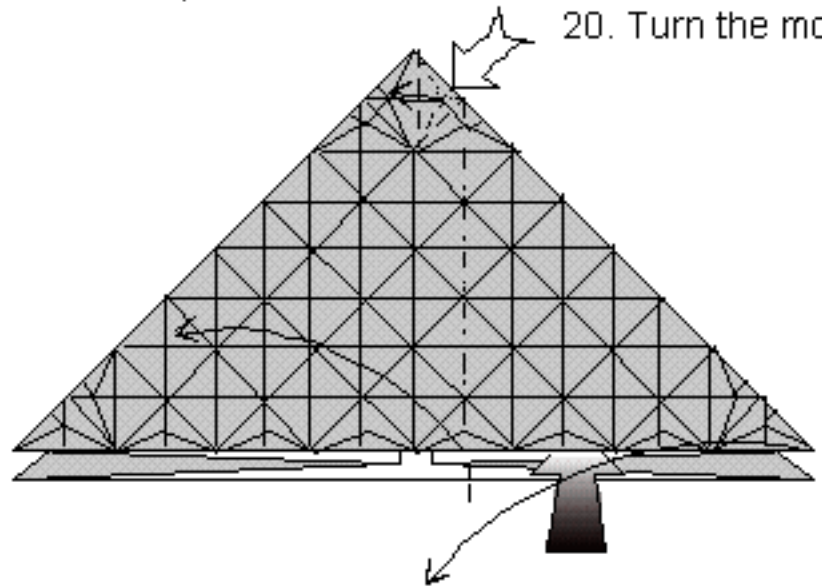

27. Lift one flap at the left side and collapse on existing creases. The paper will not lie flat.

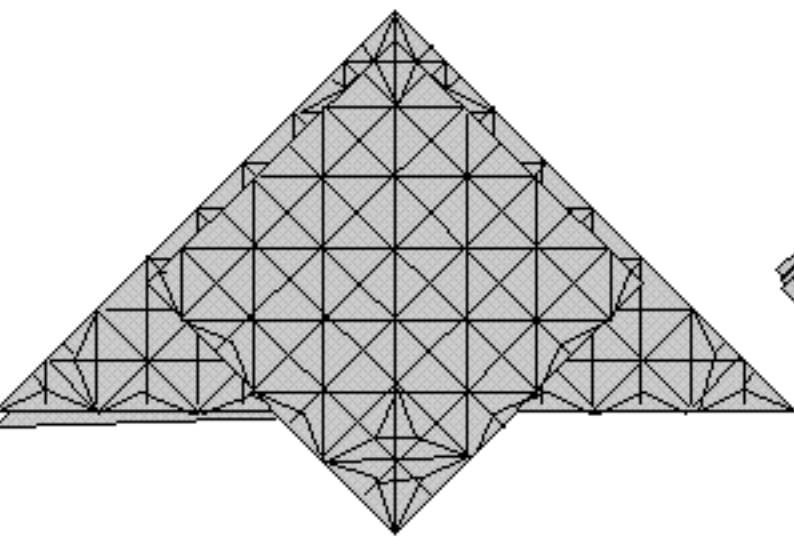

28. Repeat step 27 on the three other flaps.

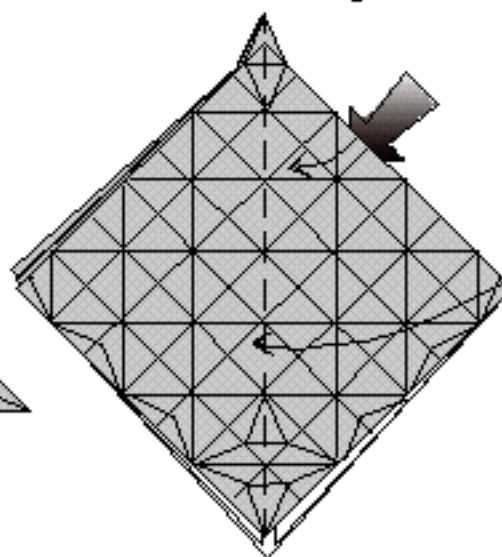

29. Swing one edge to the left. Inside, book-fold one of the small edges to the left.

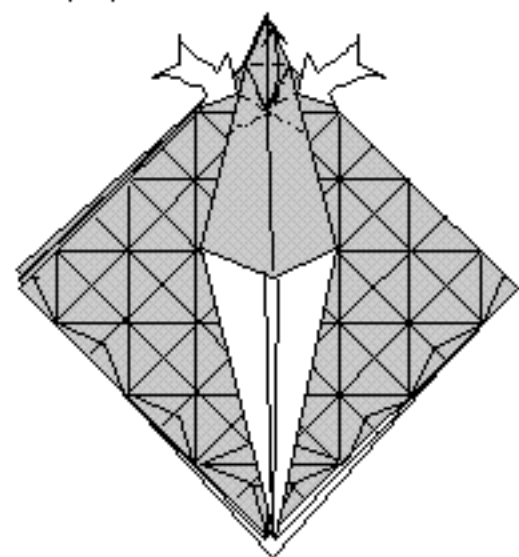

30. Closed-sink the corner to the top and collapse on existing creases. The model will not lie completely flat.

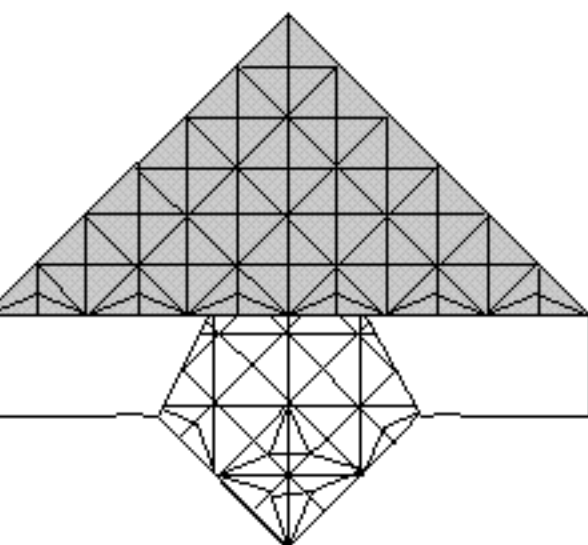

31. Repeat steps 29 - 30 on the three similar flaps.

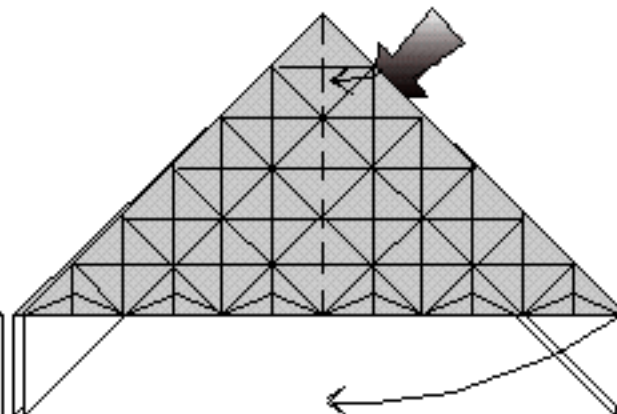

32. Repeat step 29.

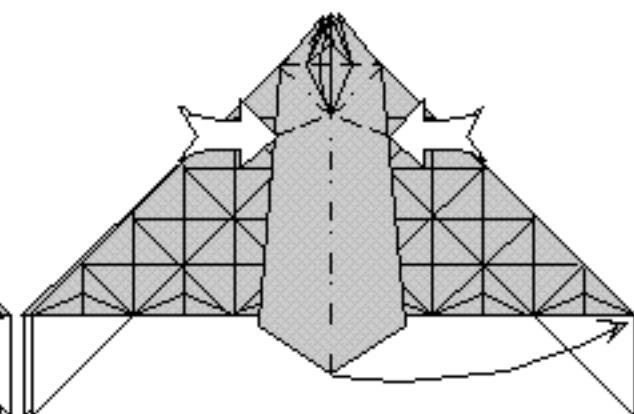

33. Closed-sink the corner up as in step 30, and collapse on existing creases.

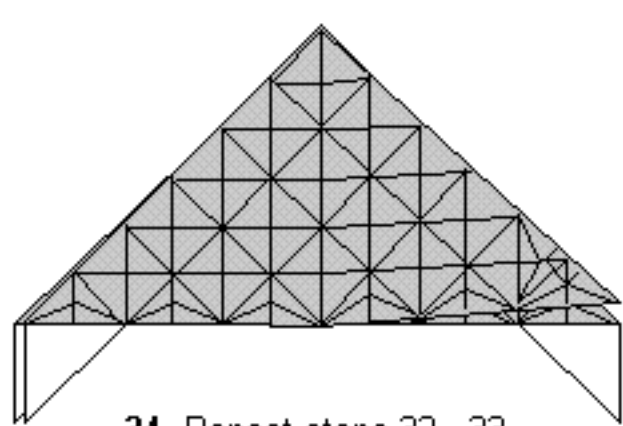

34. Repeat steps 32 - 33 on the three similar flaps.

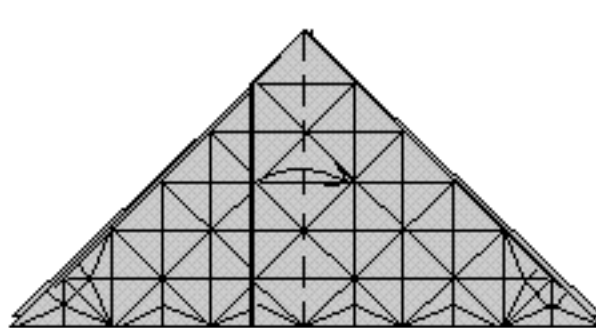

35. Book-fold one edge to the right.

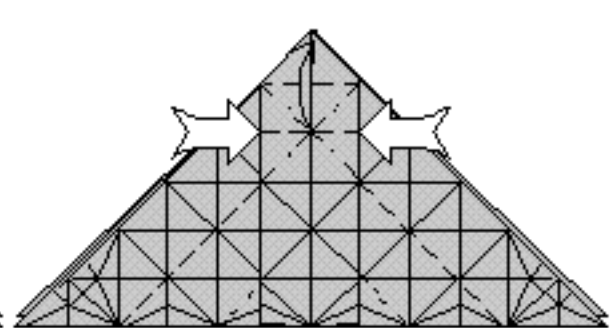

36. Push in the sides and collapse on existing creases.

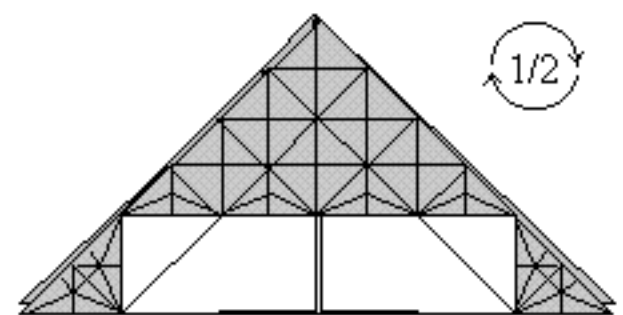

37. Repeat steps 35 - 36 on the three similar places. Then rotate the model 1/2 turn clock-wise.

1/2

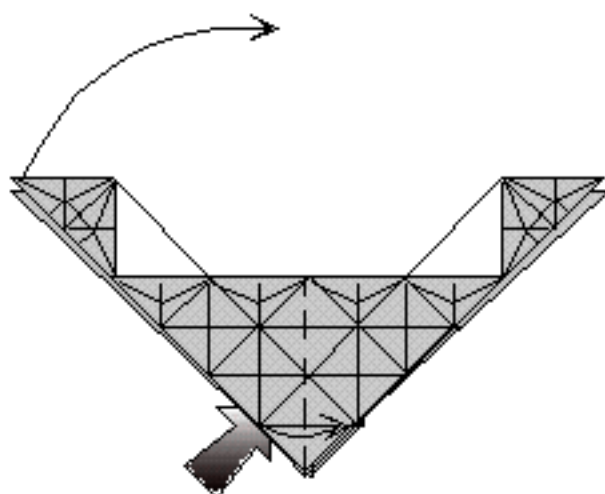

38. Lift one large flap and fold the bottom of the right edge to the right.

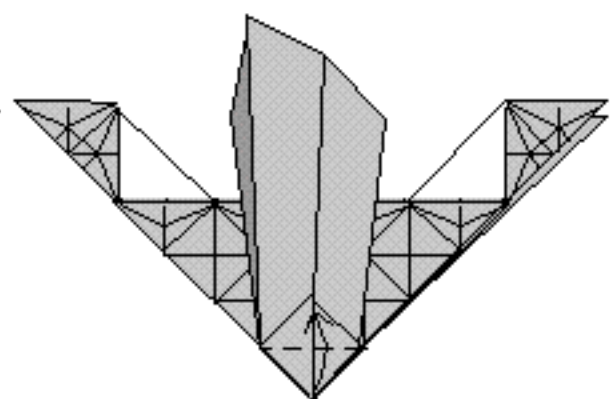

39. Valley-fold one triangular flap upward.

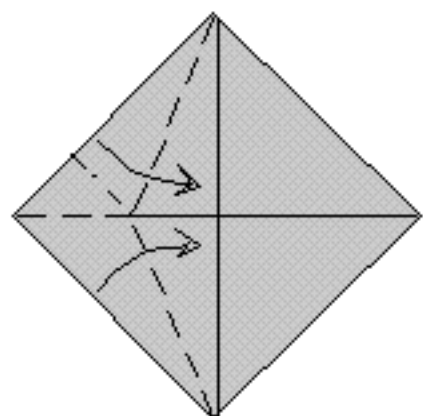

40. Enlarged view of the bottom corner. Fold a rabbit ear.

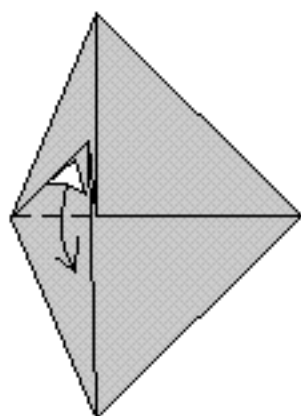

41. Fold and unfold several times.

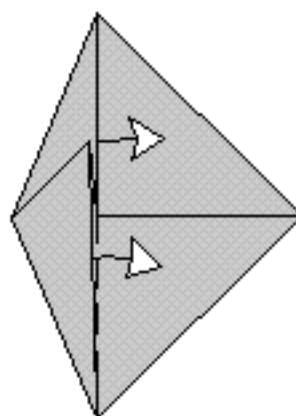

42. Pull a single layer of paper out from inside the rabbit ear.

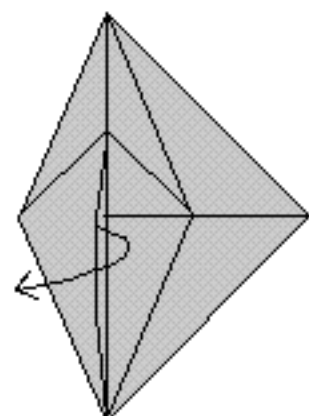

43. Open out the pocket slightly.

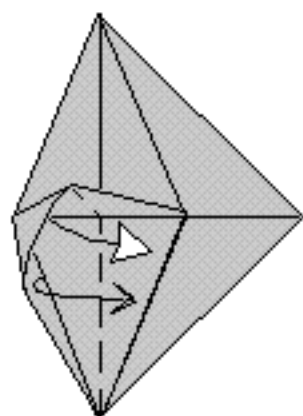

44. Pull all the edges out from inside the pocket, turning a layer inside-out as you go.

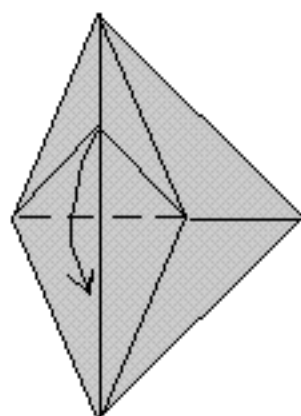

45. Fold the point down.

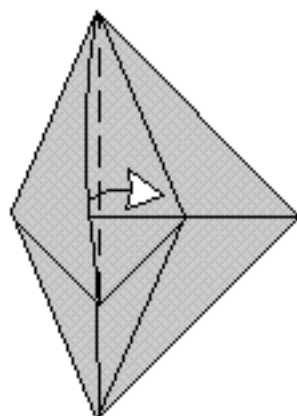

46. Repeat steps 43- 44 on the top.

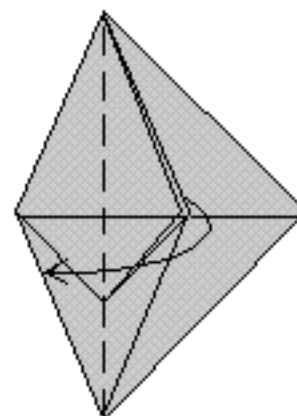

47. Fold all of the layers to the left.

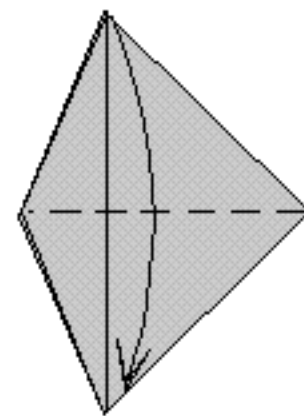

48. Fold the loose point down.

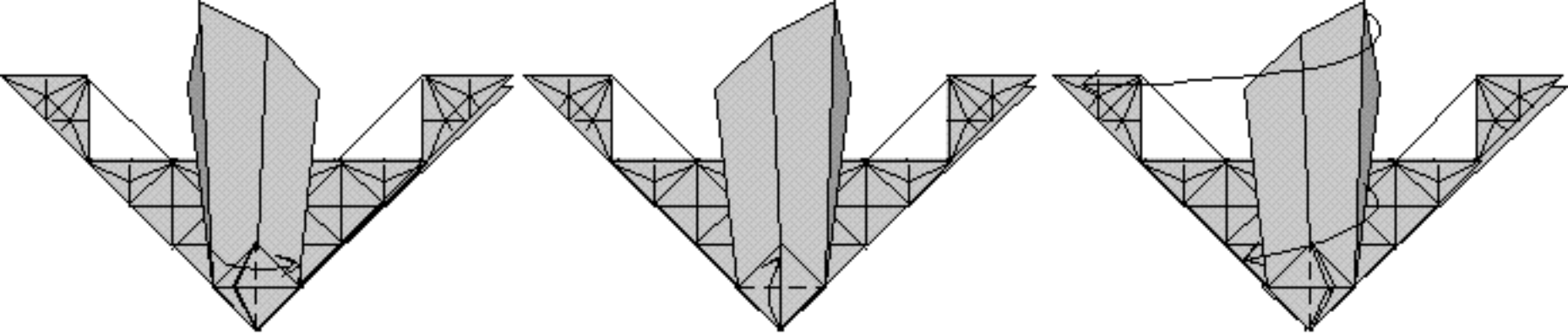

49. Fold one long edge and then one triangular flap to the right.

50. Repeat steps 39 - 48.

51. Swing the large flap back to the left and flatten.

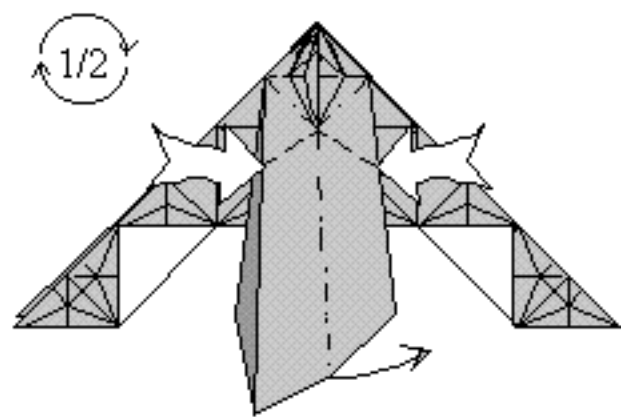
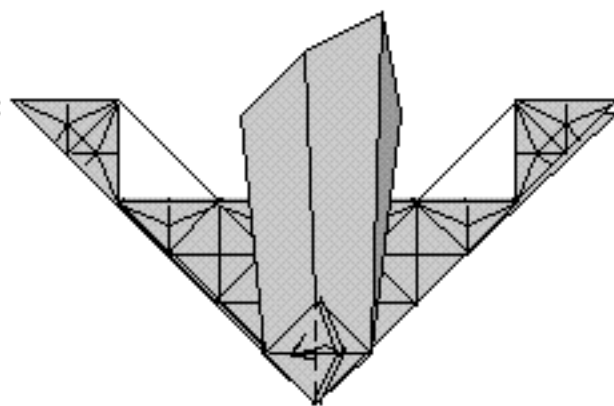
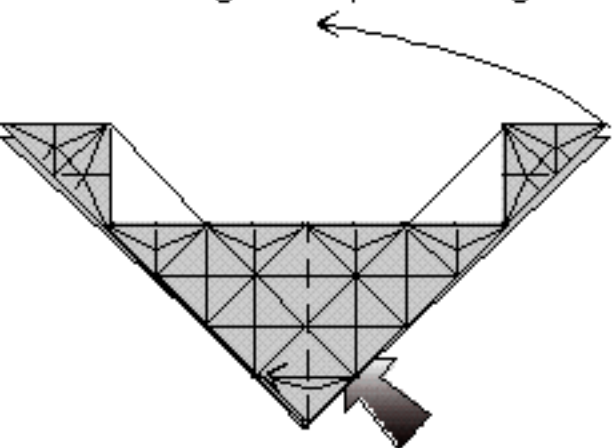

52. Repeat steps 38 - 51 on two large flaps and 38 - 50 on the third.

53. Fold one small flap to the left. Then rotate the model 1/2 turn.

54. Closed-sink the corner to the top and collapse on existing creases. The model will not lie flat.

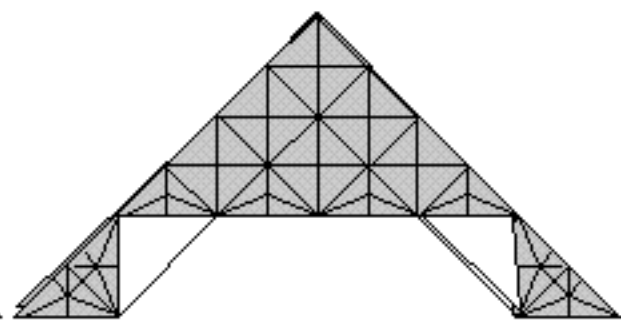
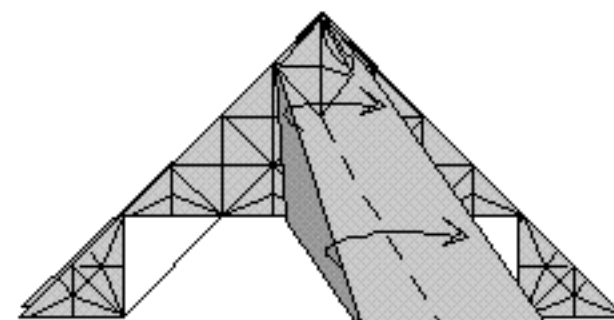
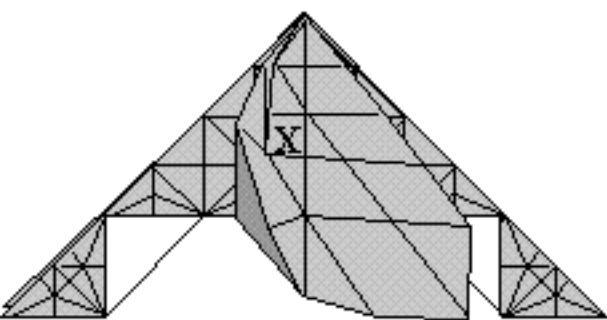

55. Open out from the inside the paper marked X. Simultaneously, closed-sink the corner underneath it upward, as in step 54. The two small flaps should be on each side of the sink, as in step 54. Collapse on existing creases.

56. Like this. Fold the flap to the right.

57. Repeat steps 53 - 56 on the three other flaps.

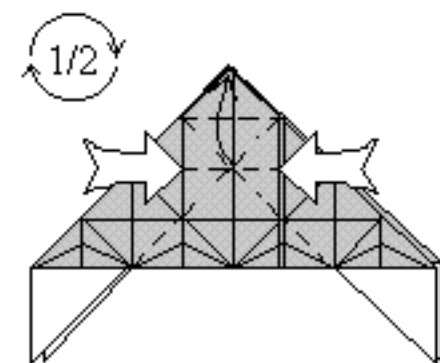
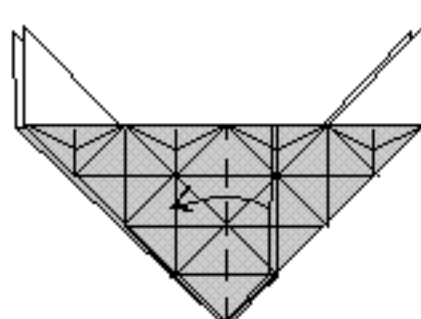
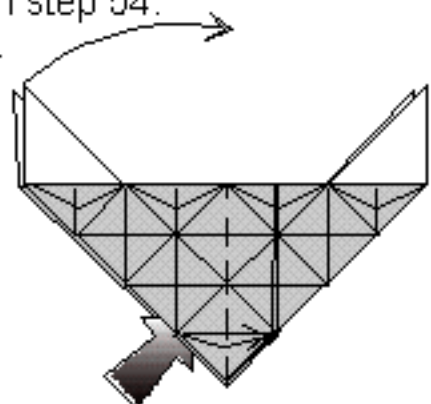
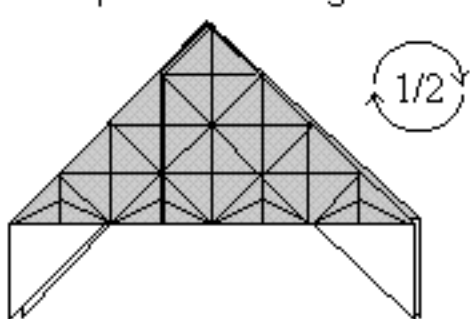

58. Rotate the model 1/2 turn.

59. Repeat steps 38 - 48 + 51 on all four flaps.

60. Book-fold one edge to the left. Then rotate the model 1/2 turn.

61. Push in the sides and collapse on existing creases.

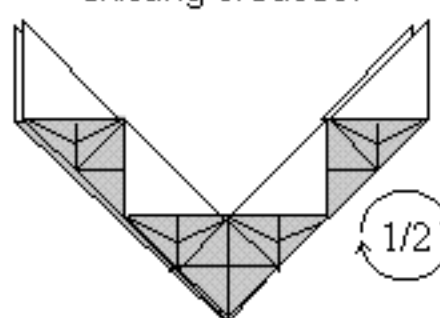
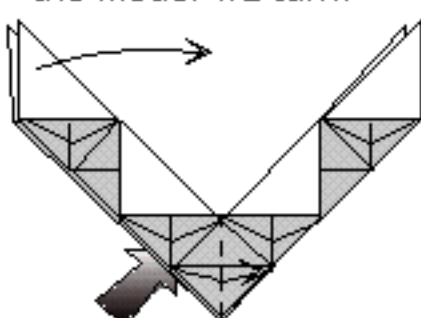
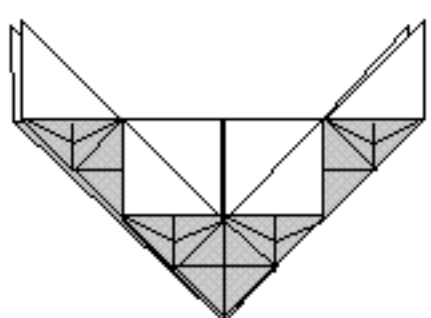
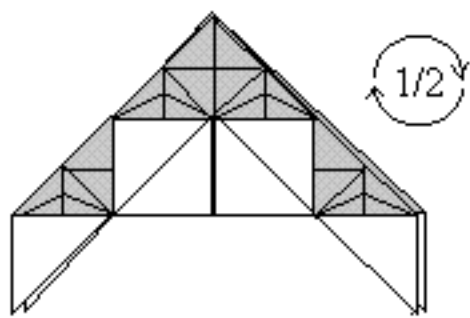

62. Rotate the model 1/2 turn.

63. Repeat steps 60 - 62 on the three other sides.

64. Repeat steps 38 - 51 on all four flaps.

65. Rotate the model 1/2 turn.

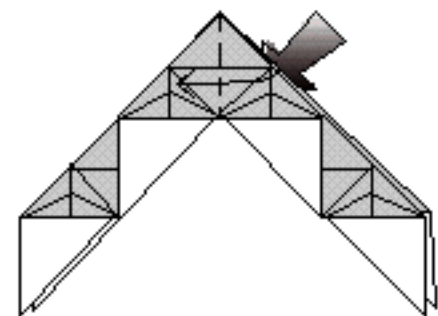

66. Valley-fold two 45° edges + one of the two small flaps inside to the left. Then repeat steps 54 - 56. Step 55 has to be done twice, one time on each side of the large flap.

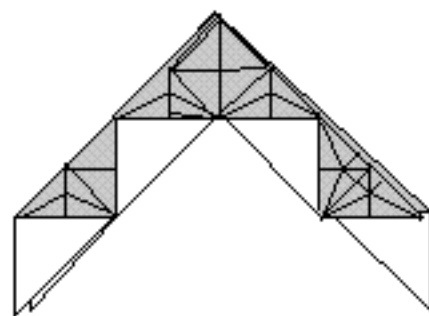

67. Repeat step 66 on the three other large flaps.

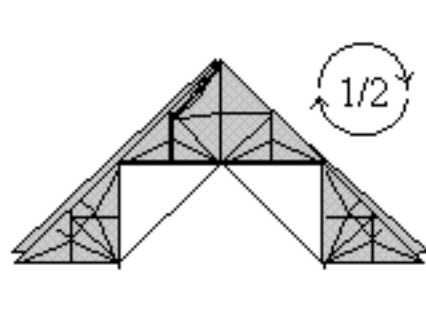

68. Rotate the model 1/2 turn.

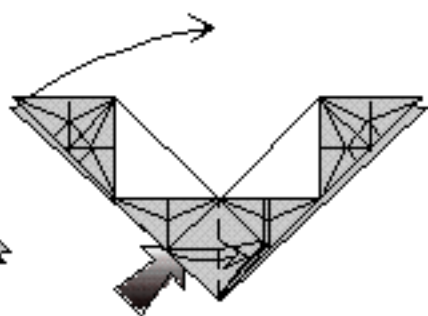

69. Repeat steps 38 - 57! The model is now getting very thick. Be careful!!

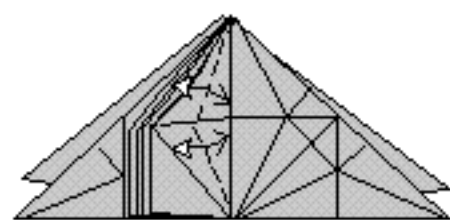

70. Crease the angle bisectors on the first of the four edges.

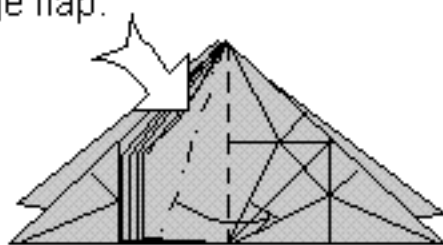

71. Squash-fold the edge, but flatten only its upper half.

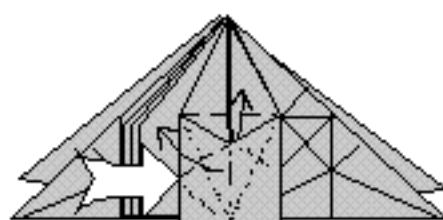

72. Pinch the sides of the lower part of the squash and swing the resulting flap to the left.

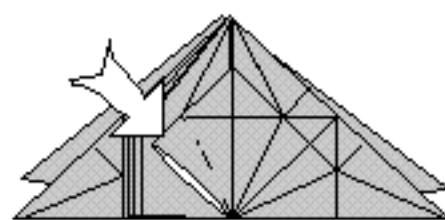

73. Reverse-fold the edge on existing creases.

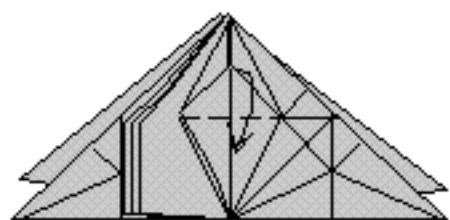

74. Fold the point down.

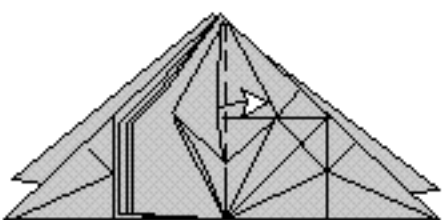

75. Pull all the folded edges out of the pocket as in step 46.

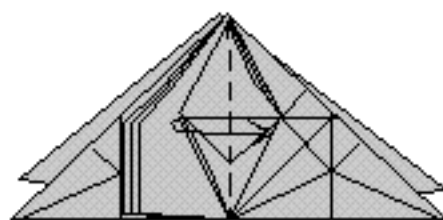

76. Fold all layers to the right.

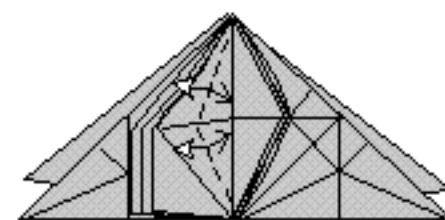

77. Repeat steps 70 - 76 on the 15 similar edges.

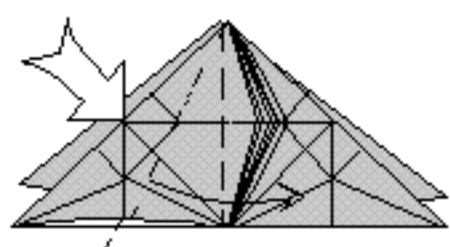

78. Squash-fold on existing creases, but flatten only the upper half.

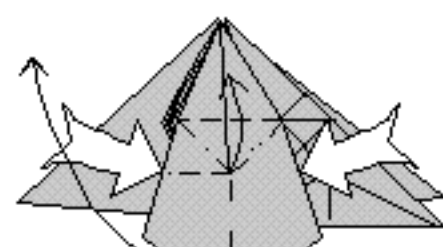

79. Pinch the lower edges of the squash-fold together and collapse on existing creases.

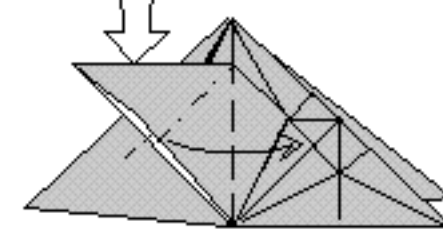

80. Squash-fold.

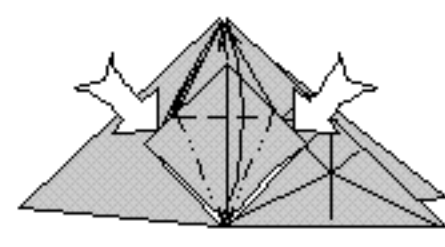

81. Petal-fold.

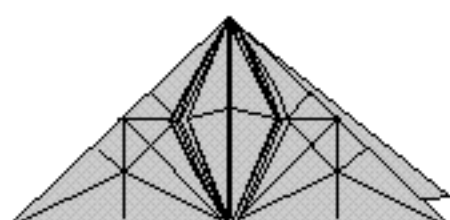

82. Repeat steps 78 - 81 on the three other flaps.

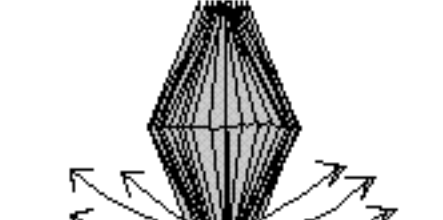

83. Reverse-fold the 28 points at the bottom outward and rabbit-ear each of them.

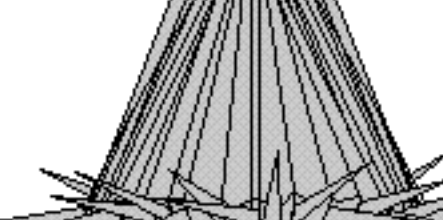

84. Rabbit-ear each of the 53 points at the top outward and adjust all 81 points to point in all directions. Then pinch all points to make them thinner.



85. Detail of a single point. Fold a rabbit ear.

86. Like this.



87. Pacific Giant Red Sea Urchin