

TURKISH VAN CITY CAT

J. Aníbal Voyer

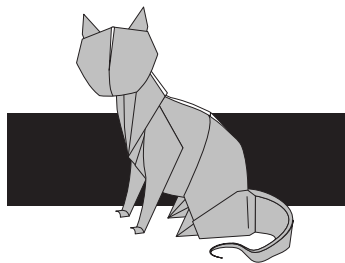

1 

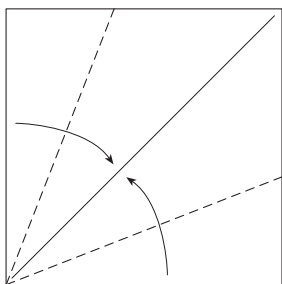

2

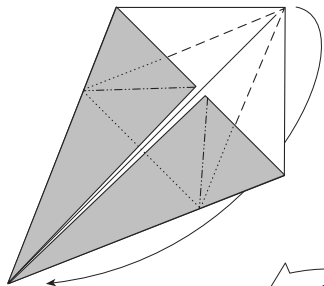

3

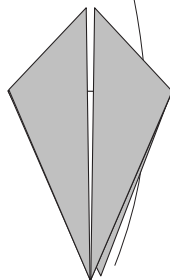

4 Base Pez

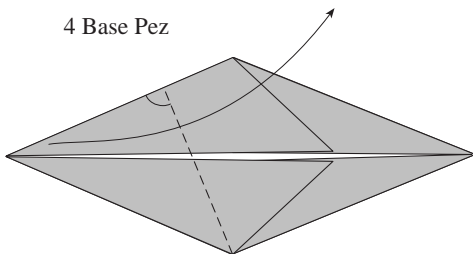

5

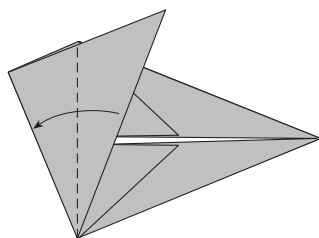

7 Repetir 4 y 5
al otro lado

6

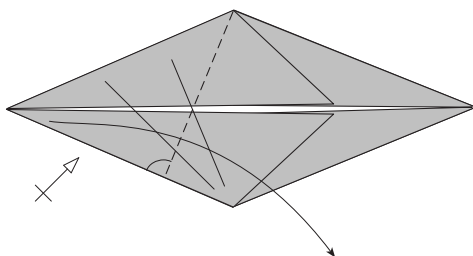
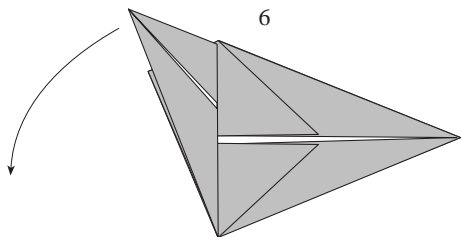

8

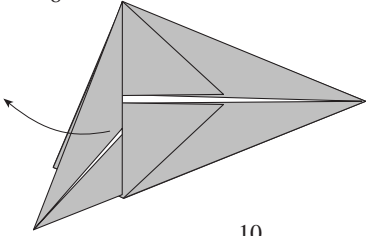

9

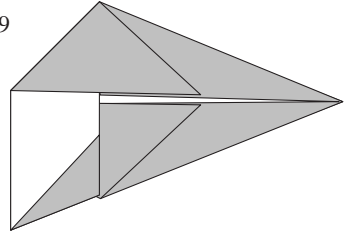

10

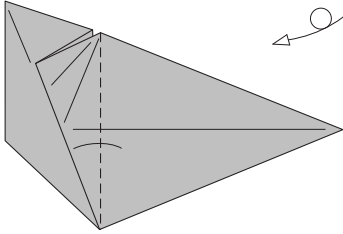

11

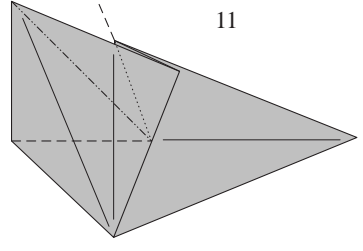

12

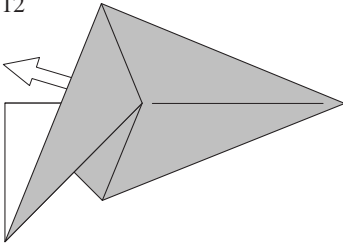

13

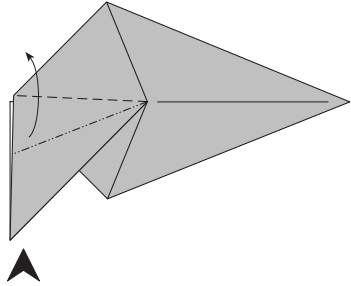

14

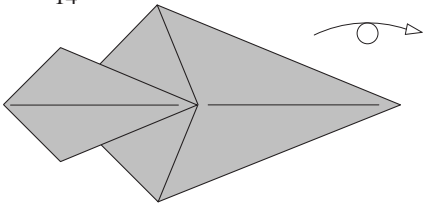

15

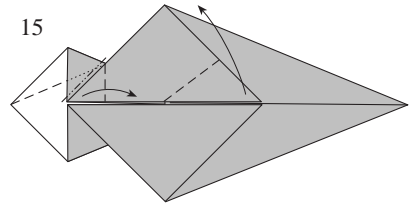

16

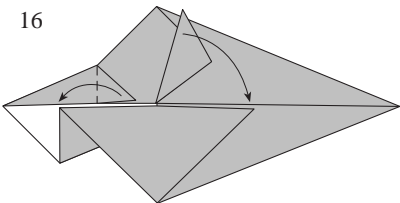

17

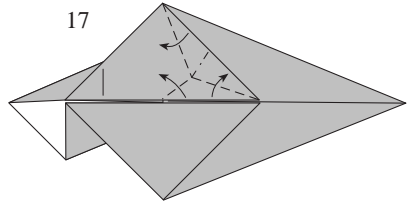

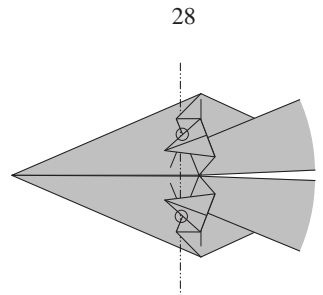
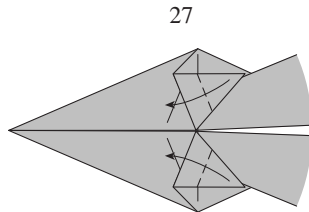
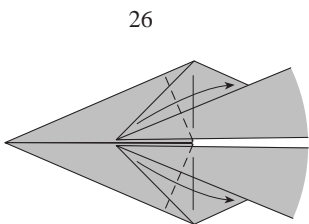
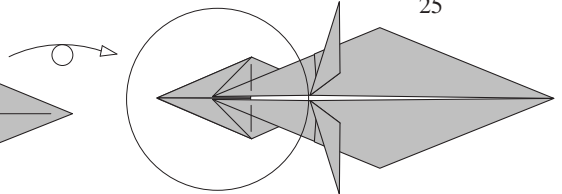
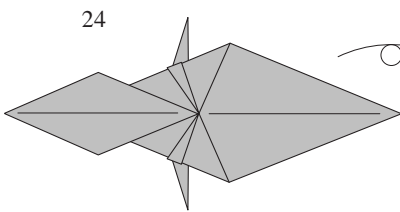
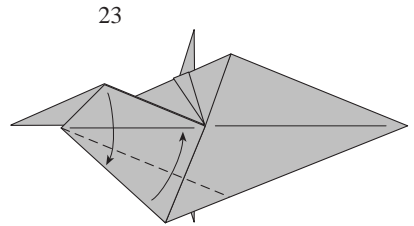
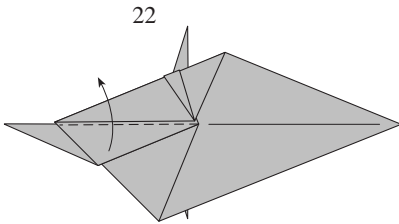
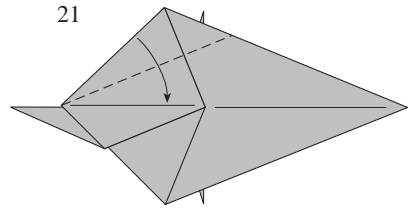
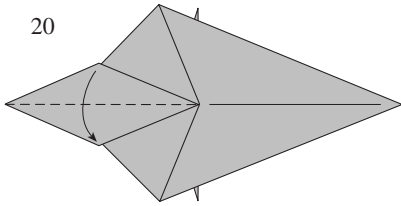
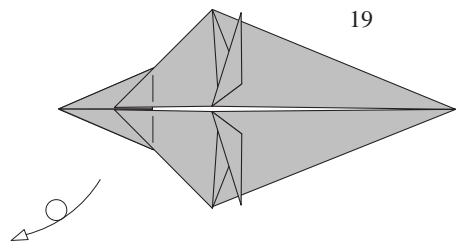
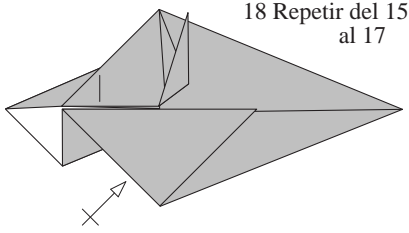

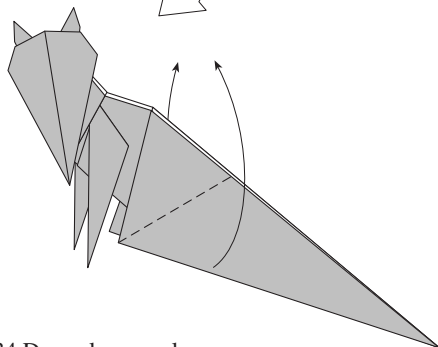
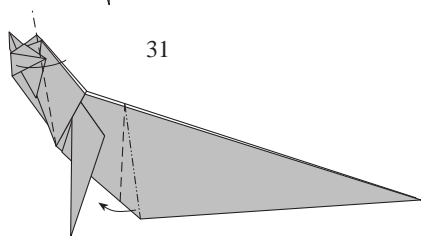
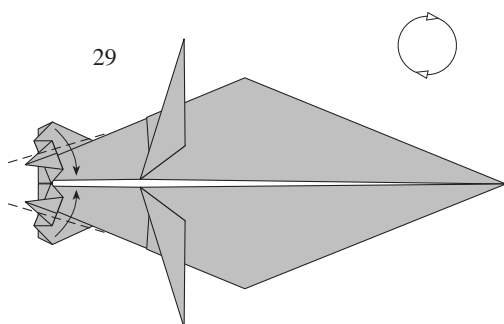

34 Dar volumen a la cabeza y al cuerpo

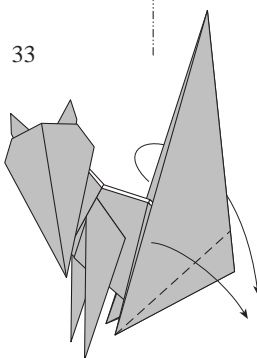
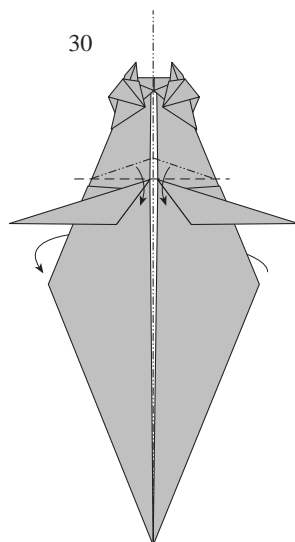
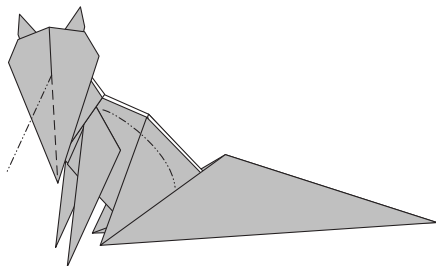

35 El paso de la cola solo se puede plegar si se ha dado volumen al cuerpo

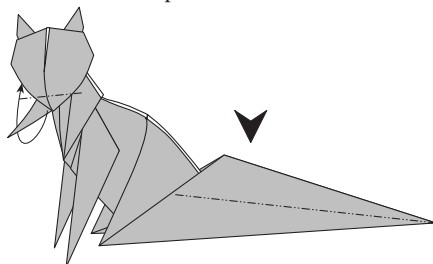

36 Adelgazar la barriga del gato

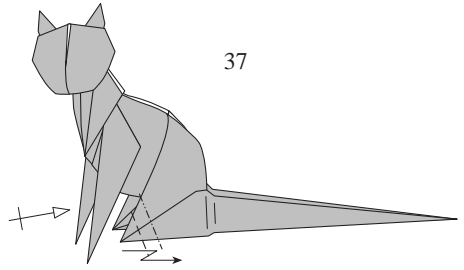
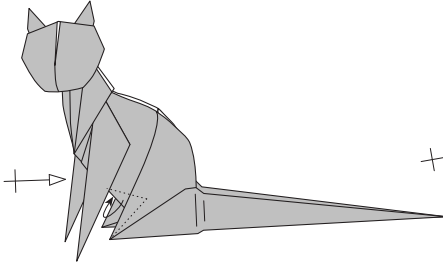

37

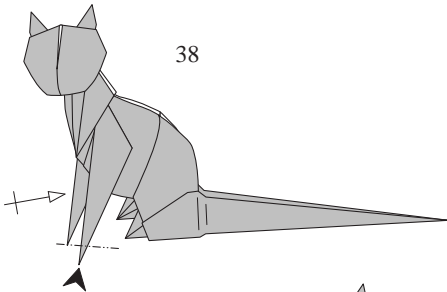

38

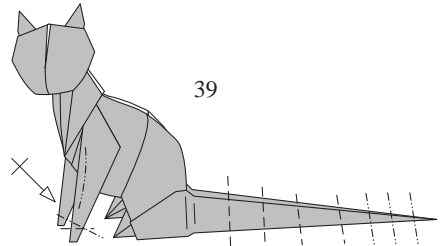

39

